

DIGITAL PIANO USER MANUAL

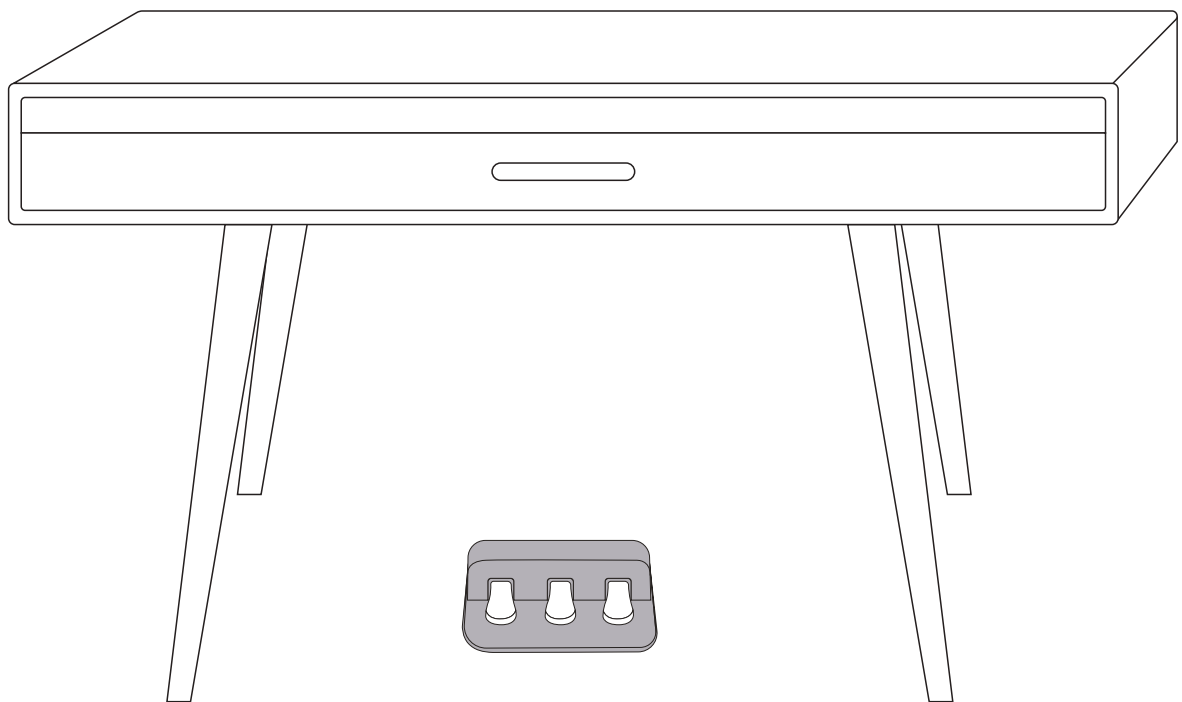

简体中文

ENGLISH

This product is subject to change without prior notice



FUNCTION INTRODUCTION

Thank you for choosing our digital piano. This product is elegant and exquisite. It is the perfect presentation of contemporary new electronic technology and acoustics.

- Before using the instrument, you must read this manual carefully.



DIGITAL SOUND SOURCE BASED ON DSP

Its core uses DSP new digital sound source, digital audio analog sampling, for your performance to bring realistic hearing experience.

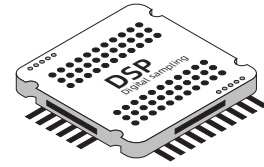

88 PROGRESSIVE HEAVY HAMMER KEYS

88 key progressive lever heavy hammer keyboard gives you a real touch like playing on a grand piano.

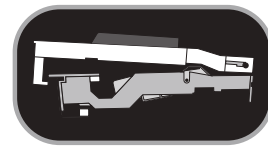

- Keyboard: 88 standard heavy hammer keyboard
- France dream dream sound source
- Tone: electric piano tone
- Power switch/master volume control
- Soft pedal / Sostenuto pedal / sustain pedal
- MIDI function / audio output / audio input
- Dual headphone audio output
- USB interface link: cell phone, tablet, computer

REMARK !

- This product is an electro-acoustic instrument product. It is normal that there is a little current sound in the speaker or earphone after power-on.
Keep away from "radio, TV, antenna receiver, router, refrigerator, TV, motor and other RF electrical interference sources" during use.



| | |
|-----------------------------------|----|
| Function introduction----- | 1 |
| Catalog ----- | 2 |
| Installation guide ----- | 3 |
| Wooden stand installation----- | 3 |
| Connecting pedal cable----- | 3 |
| Illustration of the socket----- | 4 |
| Power cord connection----- | 4 |
| Audio output/input interface----- | 4 |
| MIDI output/input interface----- | 4 |
| USB transfer interface----- | 4 |
| Foot pedal connection----- | 4 |
| On/Off----- | 4 |
| Volume----- | 4 |
| Dual headphone jacks----- | 4 |
| Pedal unit function ----- | 5 |
| Product Maintenance ----- | 6 |
| Safety Precautions ----- | 7 |
| Warranty Card ----- | 10 |



Installation Guide

Note !

- This product needs to be installed by adults, do not allow minors to install independently!
Read the "Safety Precautions" in the user manual carefully before use.

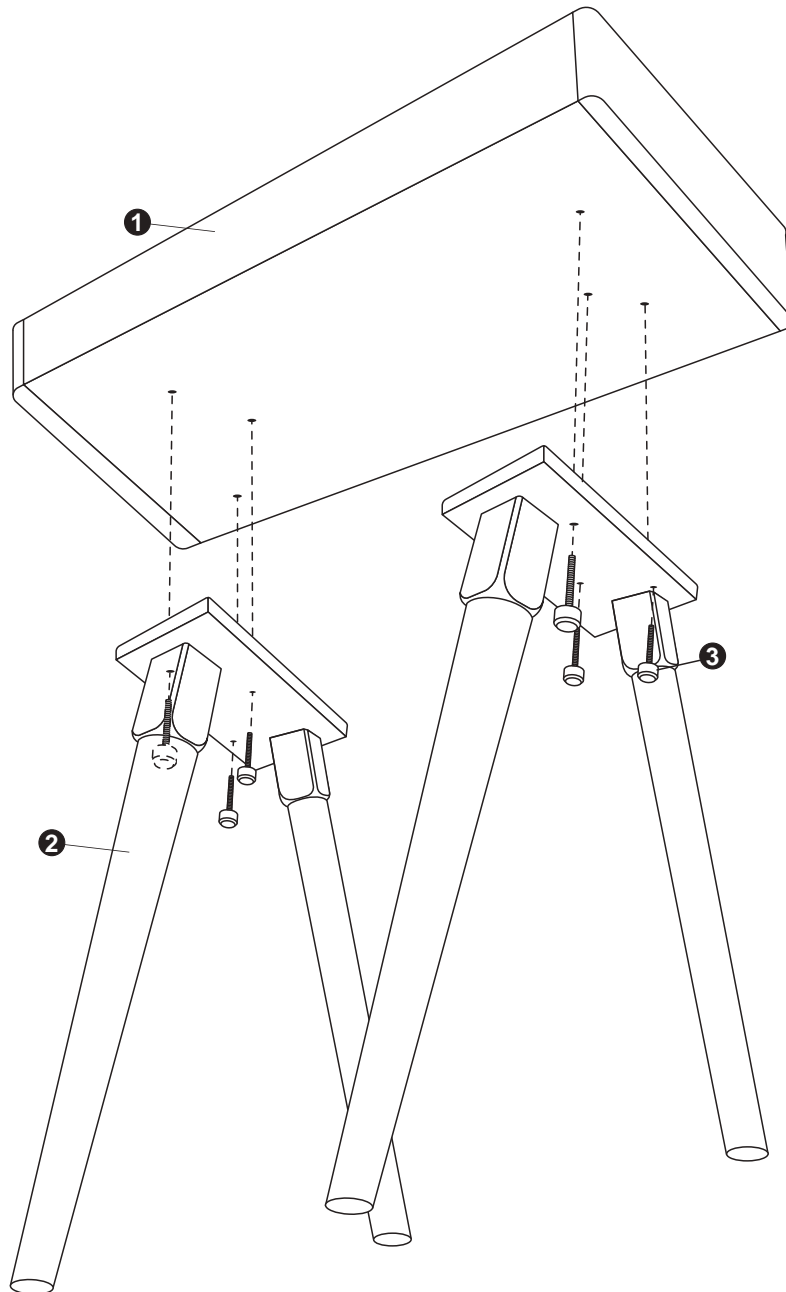

- ❶ Piano box
- ❷ Legs= 2pcs
- ❸ Screw= 6pcs

Immediately after opening the package, please check if it contains all items. If anything is missing, please contact your



Illustration of the socket

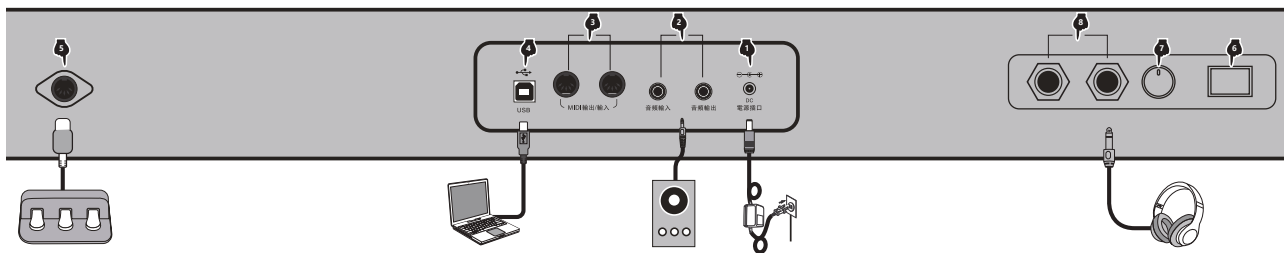

1 Power cord connection

1. Plug in the power cord as shown in the diagram, one end into the power port of the drum box, and the other end into a 100-240V household power outlet (Figure 1)
2. When the product is not used for a long time, please unplug the power cord and store it properly.

2 Audio input/output plugs

The audio input jack allows you to connect an external audio source to the drum host box for playback (e.g. MP3, linear audio signal input for cell phones, etc.). (Figure 2)

3 MIDI in/out jacks

Use the MIDI interface of this digital piano to connect and interact with music devices with MIDI. MIDI (Musical Instrument Digital Interface) is a standard format for data transmission/reception. It can be used on MIDI devices and personal transfer of performance data and commands between computers. (Figure 3)

4 USB transfer interface

Use the USB transfer interface of this digital piano to connect to your computer. Through the music software pre-installed on the computer, learn or play the keyboard for playing, composing, storing and other functional operations. The edited music and the built-in accompaniment of the music software can be connected to the digital piano through the software. The edited music and the built-in accompaniment of the music software can be connected to the digital piano through the software for playback or playing according to the accompaniment music. (Figure 4)

5 Foot pedal connection

Plug the pedal cord end into the round socket on the bottom of the instrument to turn on the 3 pedal sound effect functions! (Figure 5)

6 On/Off

Press the <switch> button to turn on the volume power, and then press it again to turn off. (Figure 6)

7 Volume

Turn the <Volume> knob to adjust the volume level. (Figure 7)

8 Dual headphone jacks

Connecting the headphones will automatically cut off the output of the built-in speaker of the electronic piano, so as not to disturb others when playing.

This product has two headphone jacks, so you can plug in two sets of headphones at the same time. (Figure 8)



Pedal unit function

The optional pedal unit is equipped with 3 foot pedals that produce a variety of intense effects similar to those of acoustic piano pedals.

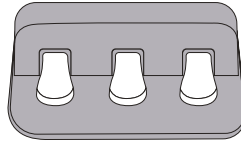

1 Sound-making (right) pedal

The damper pedal functions in the same way as the damper pedal on an acoustic piano. When the damper pedal is depressed, the note will be extended. Releasing the pedal immediately stops the sound.

The "half-pedal" effect helps you create a half sustain effect with the damper pedal, depending on how far you depress the pedal.

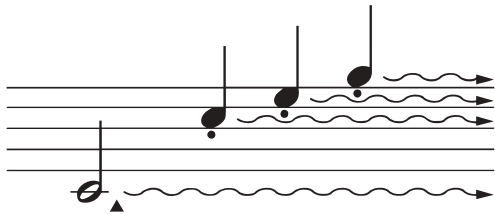

➔ If you depress the damper pedal here, the note played before releasing the pedal note will be extended for a longer period of time.

2 sustain (middle) pedal

If you play a note or chord on the keyboard and press the sustain pedal, as long as the pedal is pressed (just like a damper pedal) those notes will be extended, but the notes played after them will not be extended. This extends the chord note, while the other notes are "broken".

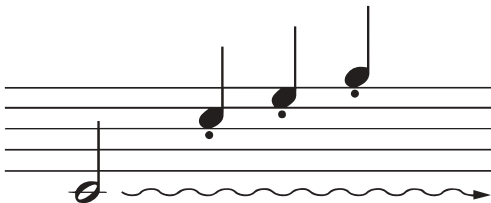

➔ If you press and hold this note and depress the sustain pedal, you can sustain the note until the pedal is released. until the pedal is released.

3 Soft Tone (Left) Pedal

Depressing the soft pedal reduces the volume and slightly changes the tone of the note being played at that moment. Depressing the soft pedal will not affect the notes already played.



PRODUCT MAINTENANCE

Careful maintenance and protection of this product plays an important role in prolonging the service life of the product and reducing the failure.

1 AVOID HEATING, DAMPNES OR DIRECT SUNLIGHT

Do not over expose the product to direct sunlight, or place it near air conditioning or extremely hot place.

2 DO NOT USE NEAR THE TV OR RADIO

This product may cause video or audio interference to the reception of TV and radio. If this happens, the product should be removed from the TV or radio.

3 NO DILUENTS OR SIMILAR CHEMICALS SHOULD BE USED FOR CLEANING

Clean the product with a soft cloth wetted with weak water solution and neutral detergent. Soak the cloth in a solution and wring it dry until it approaches drying.

4 DO NOT SHAKE, AVOID COLLISION

When moving, the product should be handled carefully and lightly. Violent vibration and collision are strictly prohibited in order to avoid damage to the shell or internal electronic components.



SAFETY PRECAUTIONS

POWER SUPPLY

This product can be powered by standard indoor wall socket. Please only use the power cord equipped with this product. Be sure to turn off the power when not in use temporarily. When not in use for a long time, please unplug the power cord and keep it properly.

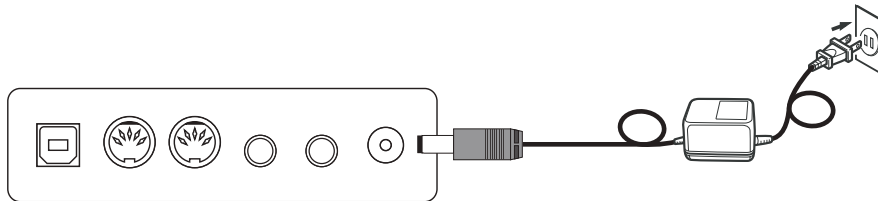

SIGN

To ensure that you use this product safely and correctly, to prevent harm to users and others and financial damage, this manual and products are marked with a series of safety signs. The various signs and their meanings are as follows:

WARNING

This sign indicates that there is a potential risk of death or serious injury if this mark is ignored and the product is mishandled.

BE CAREFUL

This sign indicates that there is a potential danger of injury to personnel or other financial damage if this sign is ignored and the product is operated incorrectly.

EXAMPLE OF LOGO



This triangle sign (\triangle) indicates what users should pay attention to. (The left example is careful shocks)



A circular sign (\odot) with an oblique line indicates prohibitions. The icons in or beside the logo indicate the contents specifically prohibited. (The example on the left is no disassembly)



The round black bottom sign (\bullet) indicates what must be observed. The diagrams in this sign indicate the contents of the specific matters that must be observed. (The example on the left is that the power plug must be pulled out of the socket)



SAFETY PRECAUTIONS









⚠ WARNING

Smoke, odor, overheating

When the product smokes, smells or overheats, there is a danger of fire and electric shock when it is used continually. In case of the above situation, the following operations should be performed immediately:



1. Turn off the power supply.
2. Pull the plug out of the power outlet.
3. Contact your dealer.

Power cord

1. The improper use of power cord may cause fire and electric shock. The following precautions must be observed:
 - The special power cord designated for this product must be used. 
 - The AC power supply with output voltage within the rated voltage range for household use must be used. 
 - Do not overload power sockets and extension lines. 
2. The improper treatment of power line will lead to its damage or breakage, which will cause fire and electric shock hazards. The following precautions must be observed:
 - Do not place or heat heavy objects on power lines. 
 - Do not attempt to alter or bend the power cord too much.
 - Do not twist or pull the power cord.
 - If the power cord or plug is damaged, please replace the same type of power cord. 
3. Do not touch the power cord and plug with wet hands, otherwise there is a danger of electric shock. 
4. Please use the power cord where the water will not splash. Water is in danger of causing fire and electric shock. 
5. Never place vases or any other container containing water on this product. Water is dangerous of causing fire and electric shock. 
6. Do not allow minors to unplug and touch power lines or connection boards. Minors have no common sense of electricity safety, which may cause electric shock. 

⚠ BE CAREFUL

The improper use of power cord may cause fire and electric shock. The following precautions must be observed:

- Never put the power cord near the oven or other heat source. 
- Do not pull the cable when pulling out of the power socket. The main body of the plug must be grasped.
- The power cord plug must be inserted in the socket to the end.
- Make sure the power supply is off before connecting or disconnecting it.
- When thunderstorms occur or before traveling or other long-term departure, disconnect the power cord from the wall outlet. 
- At least once a year, remove the power cord from the wall outlet and clean the dust accumulated around the plug.

Do not burn this product

Do not put this product in the fire, otherwise it will lead to product combustion and explosion of internal electronic components, which will cause fire and personnel injury. 

Water and foreign bodies

Water, other liquids and (metal sheets, etc.) entering this product are in danger of causing fire and electric shock. In case of the above situation, the following operations shall be performed immediately:

1. Turn off the power supply.
2. If you are using a power cord for power supply, unplug it from the wall outlet.
3. Contact your distributor.



Disassembly and transformation

Do not disassemble or transform the product in any way, otherwise there is a risk of electric shock, scald or other personal injury. All internal inspection, adjustment and maintenance operations should be entrusted to your distributor. 



SAFETY PRECAUTIONS

Falling or colliding

If the product falls or is damaged by strong impact, it will be in danger of causing fire and electric shock. In case of the above situation, the following operations shall be performed immediately:

1. Turn off the power supply.
2. If you are using a power cord for power supply, you need to unplug it from the wall outlet.
3. Contact your distributor.



Plastic bag

Do not let anyone put plastic bags for this product on his head or in his mouth. Otherwise, there is a risk of asphyxia. Families with young children should pay special attention to it.



Keep a distance from the product and the bracket

Climbing the bracket is dangerous of overturning or damage. Families with young children should pay special attention to it.



Put

Avoid placing the product on an uneven surface or any other unstable place. Otherwise, it will cause the product to fall down, which will lead to the risk of injury.



Product Mobility

Before moving this product, you must unplug the power cord plug from the wall outlet and pull out all other cables and connecting wires. Otherwise, it will lead to damage of power or connection wires, resulting in fire and electric shock.



clean

Before cleaning this product, you must unplug the power cord plug from the wall outlet, otherwise there is a risk of fire and electric shock.



Jack

The socket of this product can only be connected to the designated equipment and devices. Connecting non-designated equipment or devices is dangerous of causing fire and electric shock.



Location selection

It should be avoided to place the product in the following places, otherwise there is a risk of fire and electric shock.



- High temperature or dusty places.
- Kitchen or other places with lampblack.
- Where the product is exposed to direct sunlight, or any other place where the product will produce high temperature.

Volume

Don't play music long and loud. Pay special attention when using headphones. Excessive volume can damage your hearing.



Heavy

Do not place heavy objects on this product. Otherwise, the top of the product will be overweight, causing the product to overturn or drop objects on it, which will lead to the risk of injury.



Correct assembly of scaffolds

The incorrect assembly of the bracket may overturn, causing the product to fall off and posing a risk of injury to personnel. Therefore, it must be assembled according to the instructions in the attached installation guide to ensure that the product is properly mounted on its bracket.





WARRANTY CARD

Warranty rules

1. Faults arising from normal use of this product can be guaranteed free of charge for _____ days from the date of purchase.
2. Failure occurs during the warranty period. This warranty card and shopping ticket must be presented during maintenance.
3. In the following cases, no free warranty will be provided:
 - Damage caused by improper use by users.
 - Fault damage caused by irresistible factors such as fire, flood, earthquake and lightning strike.
 - Failure caused by unauthorized self-disassembly.
4. After exceeding the warranty period, the company is responsible for maintenance, but it needs to charge a cost fee.

Seller: _____

Address: _____

Telephone: _____

简体中文

ENGLISH

Maintenance record

| Date | Maintenance record | Repairman |
|------|--------------------|-----------|
| | | |
| | | |
| | | |
| | | |
| | | |

